

### 550-080 Installing Explains

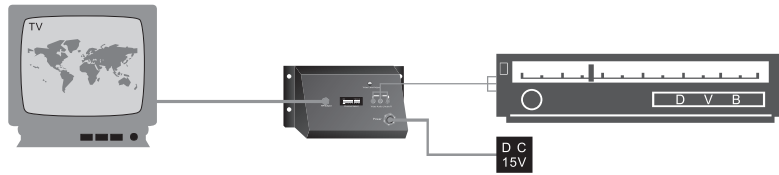

#### Instruction:

To switch the channel according to the channel list, controlled by DIPSW. For example, D47 CH, you can have DVB signal when switch the TV to channel 47.



### Wiring a 110 connector

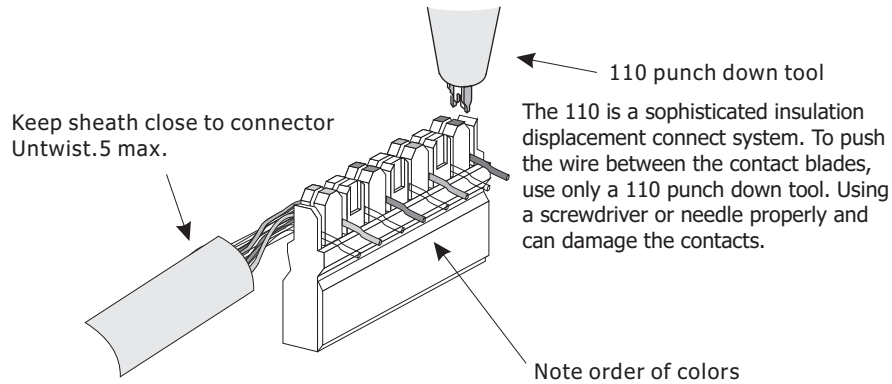

### Wiring Instruction

Punch Down Terminals	T568A Wire Color	T568B Wire Color
PIN-1	White/Blue	White/Blue
PIN-2	Blue	Blue
PIN-3	White/Green	White/Orange
PIN-4	Green	Orange
PIN-5	White/Orange	White/Green
PIN-6	Orange	Green
PIN-7	White/Brown	White/Brown
PIN-8	Brown	Brown

# RESIDENTIAL STRUCTURE WIRING SYSTEM

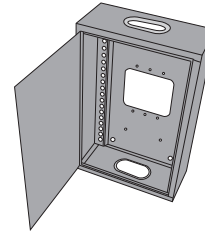

### 550-100

Master of Wall  
Wall mount residential structure  
Wiring enclosure accept  
Any 3 of following components:  
550-010, 550-020, 550-030, 550-040,  
550-050, 550-060, 550-070, 550-080  
Size: 260 x 170 x 85 mm

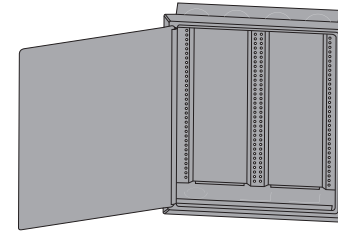

### 550-200

Master of Wall  
Wall mount residential structure  
Wiring enclosure accept  
Any 8 of following components:  
550-010, 550-020, 550-030, 550-040,  
550-050, 550-060, 550-070, 550-080  
Size: 540 x 365 x 95 mm

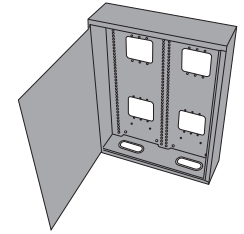

### 550-105

Master of Wall  
Wall mount residential structure  
Wiring enclosure accept  
Any 7 of following components:  
550-010, 550-020, 550-030, 550-040,  
550-050, 550-060, 550-070, 550-080  
Size: 480 x 368 x 110 mm

### 550-100, 550-105 Installing Explains

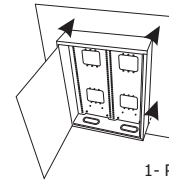

1- Put well the box according to the need.

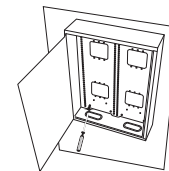

2- Fix the box with the screw.

### 550-200 Installing Explains

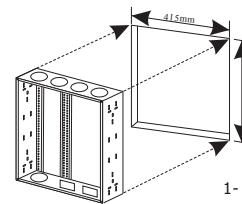

1- Put the box into the wooden shelf.

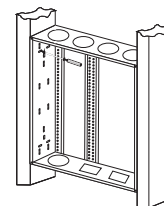

2- Fix the box with the screw.



### Packing the products into the box

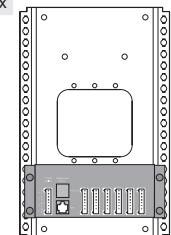
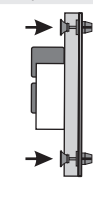

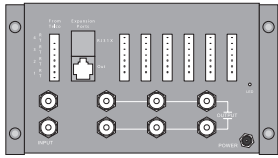

**550-010**  
**Starter System**  
 RF splitters and telephone punch downs, RF splitter is the distribute antenna or cable TV to every room of the house.  
 Telephone (4 lines x 6 phone connections for 1-4 phone lines to every room.)  
 SPEC of RF splitters: SPEC of Telephone;  
 Insertion:  $0 \pm 1$  db According to CAT5 standard  
 Isolation: 20 db  
 Return loss: 10 db  
 Size: 165 x 110 mm

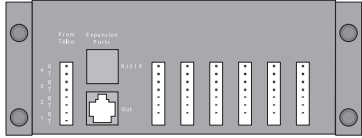

**550-020**  
**Telephone Hubs (4 lines x 6 phones)**  
 Connections for 1-4 phone to every room, with expansim port.  
 Starter hub adds RJ-31X jack for.  
 SPEC:  
 According to ISO/IEC standard.  
 Size: 165 x 64 mm

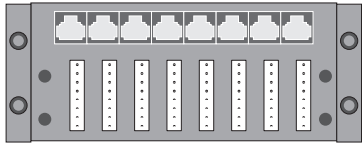

**550-030**  
**Data Hubs**  
 Termination blocks for the CAT5cables, Ethernet Hubs. Bring the internet to any room in the home. Or create a home data network.  
 SPEC:  
 According to CAT5 standard  
 Size: 165 x 64 mm

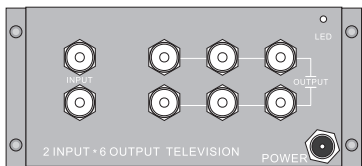

**550-040**  
**2 Input x 6 Output Television**  
 Or cable TV to every room of the house.  
 RF splitter is the distribution antenna.  
 SPEC:  
 Insertion:  $0 \pm 1$  db  
 Isolation: 20 db  
 Return loss: 10 db  
 Size: 165 x 64 mm

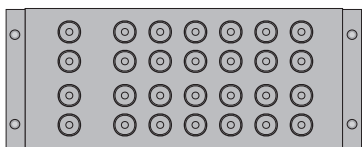

**550-050**  
**Audio Splitter (1 input x 6 output)**  
 The audio splitter is a distribution, distribute audio signal to six room in the home.  
 Size: 165 x 64 mm

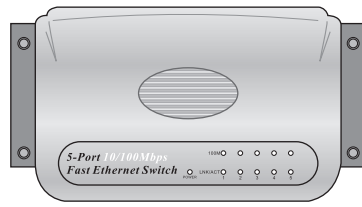

**550-060**  
**HUB (1 input x 5 output)**  
 SPEC:  
 Network standard: IEEE 802.3 / IEEE 502.3u  
 10/100 Mbps Port (RJ-45): 5  
 Uplink Port: Slide Switch  
 Extension Port: All ports  
 Power Supply: 12V DC 0.5 A  
 Size: 165 x 64 mm

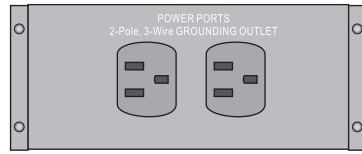

**550-070**  
**Power Ports**  
 2-Pole, 3-Wire grounding outlet

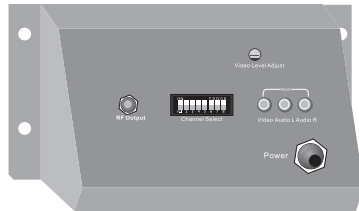

**550-080**  
 The modulator is a digitally tunes video modulator that converts any baseband video and audio signal to a user-selected UHF or Ultraband CATV channel.  
 An internal quartz crystal RF oscillator and PLL circuitry ensure drift-free performance.  
 The user selects the output frequency (channel) using the DIP switch on the output via coax can receive the signal, when tuned to the proper channel.  
 SPEC:  
 Output channel modulator: CH 14 - CH32  
 Video carrier:  $15 \pm 3$  db  
 Video amplitude frequency characteristics:  $\pm 3$  db  
 Differential phase (dp): 10%  
 Differential gain (dg): 10%  
 Video input impedance:  $75 \Omega$   
 Sound carrier frequency (The difference between the video carrier and audio carrier frequency):  $4.5 \pm 0.005$  MHz  
 Audio amplitude frequency characterist:  $\pm 3$  db  
 Sound distortion: 2% max  
 Sound S/N: 40 db min  
 Size: 165 x 64 mm

