

RoHS

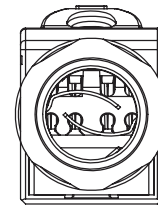

SPANNER 14mm

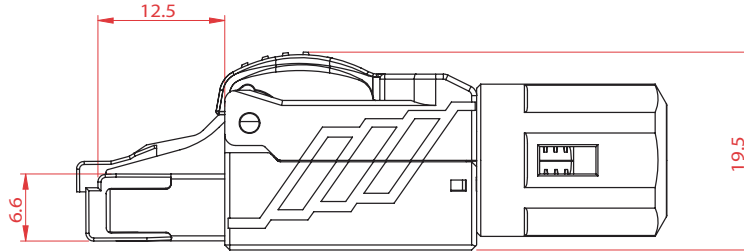
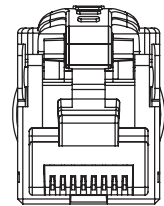
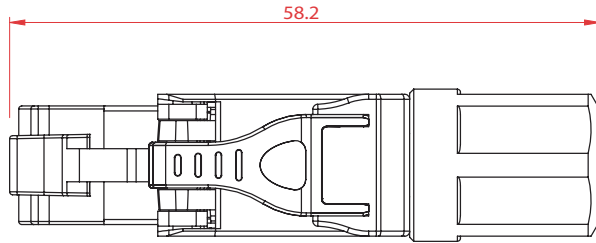
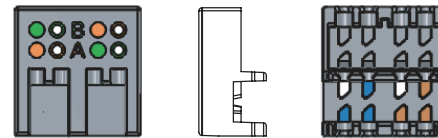
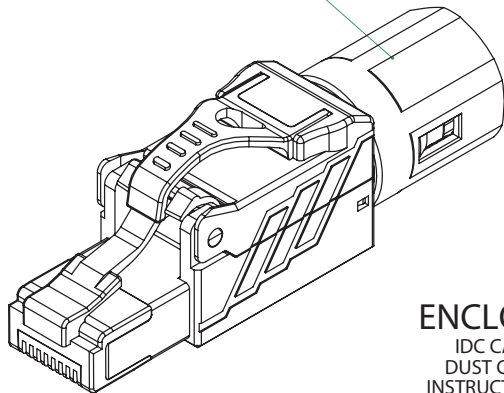

IDC CAP

ENCLOSURE
 IDC CAP X 1 PC
 DUST CAP X 1 PC
 INSTRUCTION X 1 PC

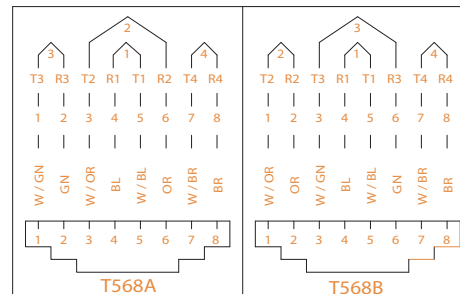

Rev.	Description	Date
A		07-2023

ACCORDING TO

ANSI/TIA-568.2-D
 ISO/IEC 11801-1
 IEC 60603-7
 IEEE 802.3bt Power over Ethernet Plus Plus(4PPoE) application
 IEC 60512-99-002 Mating and un-mating connectors under electrical load

MATERIAL

SHIELD CONTACT : NICKEL SILVER ALLOY.
 PLUG HOUSING : ZINC ALLOY, NICKEL PLATED.
 CONTACT HOLDER : PC, UL94V-0.
 PLUG CONTACTS : PHOSPHOR BRONZE, 50U" GOLD PLATED ON CONTACT AREA.
 IDC PLASTIC : PC, UL94V-0.
 IDC TERMINALS : PHOSPHOR BRONZE, TIN OVER NICKEL UNDERCOAT.

PHYSICAL CHARACTERISTICS

INSERTION LIFE : 750 MATING CYCLES.
 PLUG RETENTION FORCE : 11 LBF MINIMUM.
 INSERTION FORCE : 30 N MAXIMUM.
 RE-TERMINATION : UP TO 20 TIMES.
 CONTACT COMPATIBILITY : ACCOMMODATES 22 TO 26 AWG SOLID OR STRANDED.
 CABLE JACKET DIAMETER : 6.5 mm TO 8.5 mm
 OPERATING TEMPERATURE RANGE : -10°C TO 60°C.
 STORAGE TEMPERATURE RANGE : -40°C TO 68°C.
 HUMIDITY : 10% TO 90% RH (NON-CONDENSING).

ELECTRICAL

INSULATION RESISTANCE : 500 MΩ MINIMUM.
 DC CURRENT RATING : 1.5 Amps.
 INPUT TO OUTPUT D.C. RESISTANCE FOR SHIELD : 100 mΩ MAXIMUM.
 INPUT TO OUTPUT D.C. RESISTANCE : 200 mΩ MAXIMUM.
 CONTACT RESISTANCE : 20 mΩ MAXIMUM.
 VOLTAGE PROOF (CONTACT TO CONTACT) : 1000 V D.C. OR A.C. PEAK.
 VOLTAGE PROOF (CONTACT TO SHIELD) : 1500 V DC.

Item Number:	31D0-80000	
Title:	Cat.8 RJ45 Toolless Shielded Plug	
Drawn by:	JL	
Approved by:	MAC	
ID:	108	

No.	Specifications
-----	----------------