

RoHS

Rev.	Description	Date
A		10-2018

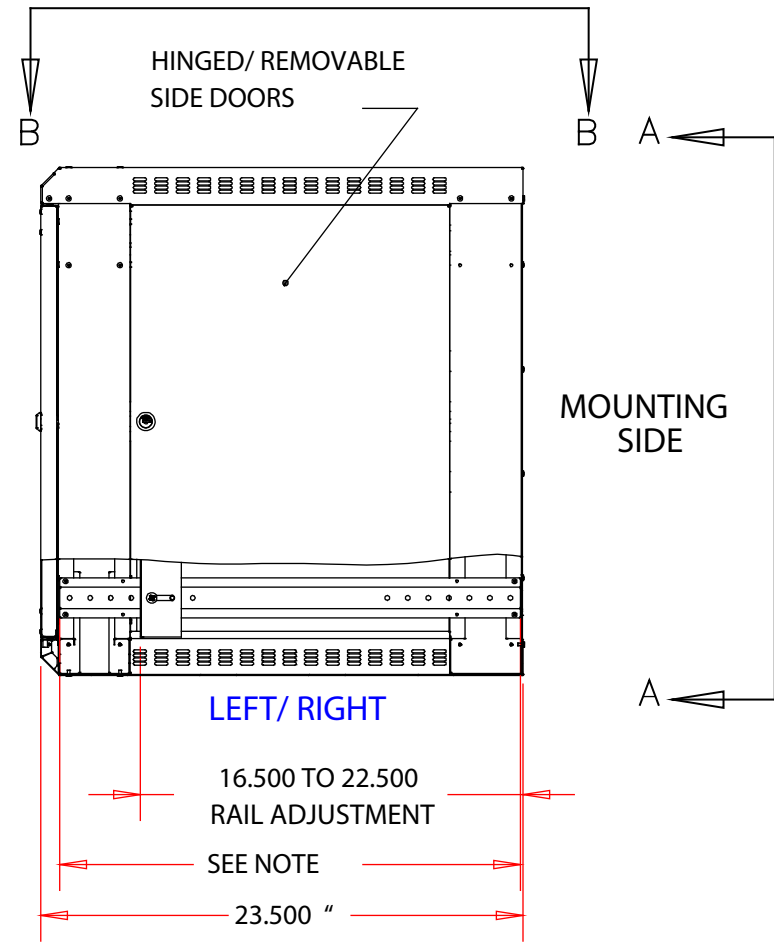
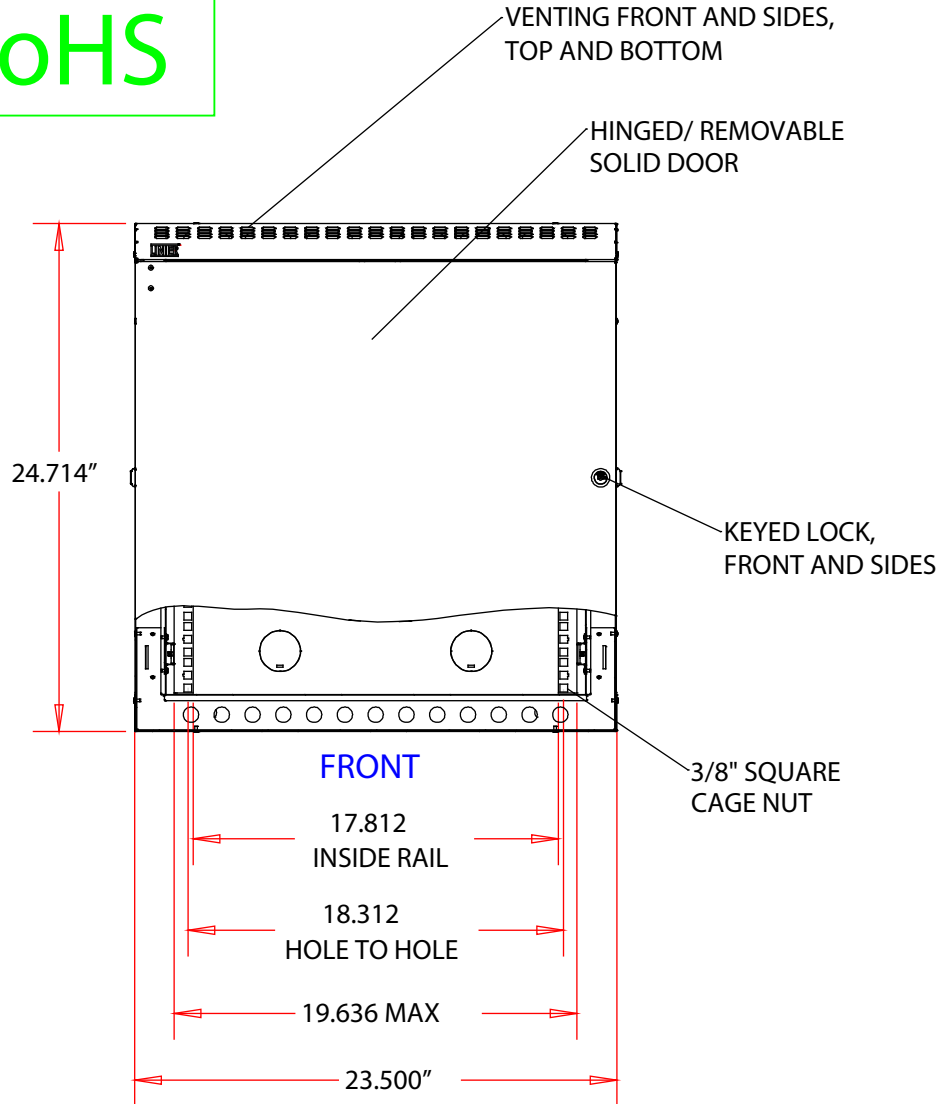
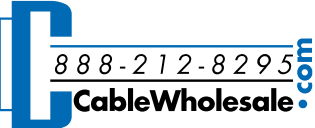

NOTE:
22.5 MAX RAIL TO RAIL
12.5 MIN RAIL TO RAIL

Item Number:	61C3-11212	
Title:	Rackmount Fixed Wall Mount Cabinet, Solid Door, 12U	
Drawn by:	JL	
Approved by:	MAC	
ID:	196	

2	
1	
No.	Specifications