

REV.	DESCRIPTION	DATE
A		12-2013

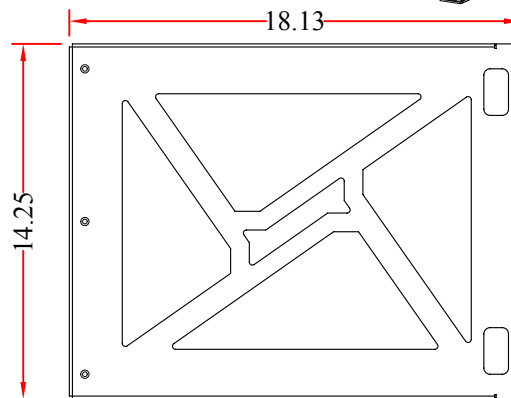
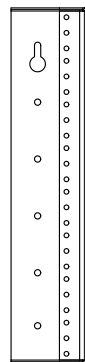
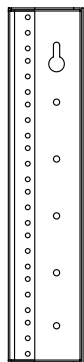
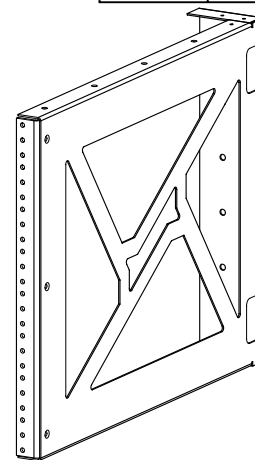
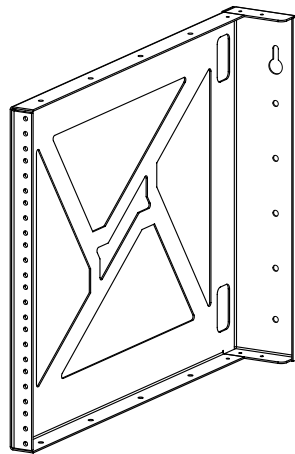
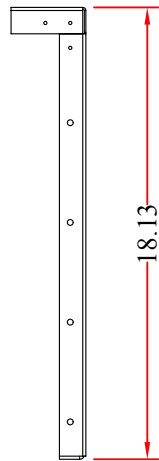
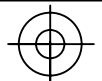
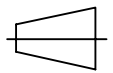

RoHS

ITEM NUMBER	61R2-21208		DRAWER	JL
TITLE	Wall Mount Rack, 8U		CHECKED	
			APPROVED	
MATERIAL	SCALE		 	
REV.	A	UNIT		INCH
DRAWING NO:			