



















Rev.	Description	Date
A		11-2018

RoHS

Package M

 M4x10 (x4) M-A	 M5x10 (x4) M-B	 M6x10 (x4) M-C	 M8x15 (x4) M-D	 D4 washer (x4) M-E
 D5 washer (x4) M-F	 D6 washer (x4) M-G	 D8 washer (x5) M-H	 Ø13.5xØ5.5X3.2 (x4) M-I	 M8 (x1) M-J
 M8 (x2) M-K	 M8x20 (x1) M-L	 M8x50 (x1) M-M	 M8 (x1) M-N	 washer (x1) M-O

Package W

 ST6.3X55 (x6) W-A	 concrete anchor (x6) W-B	 D6 washer (x6) W-C
---	--	--

Notes:
Material: Aluminum, Steel, Plastic

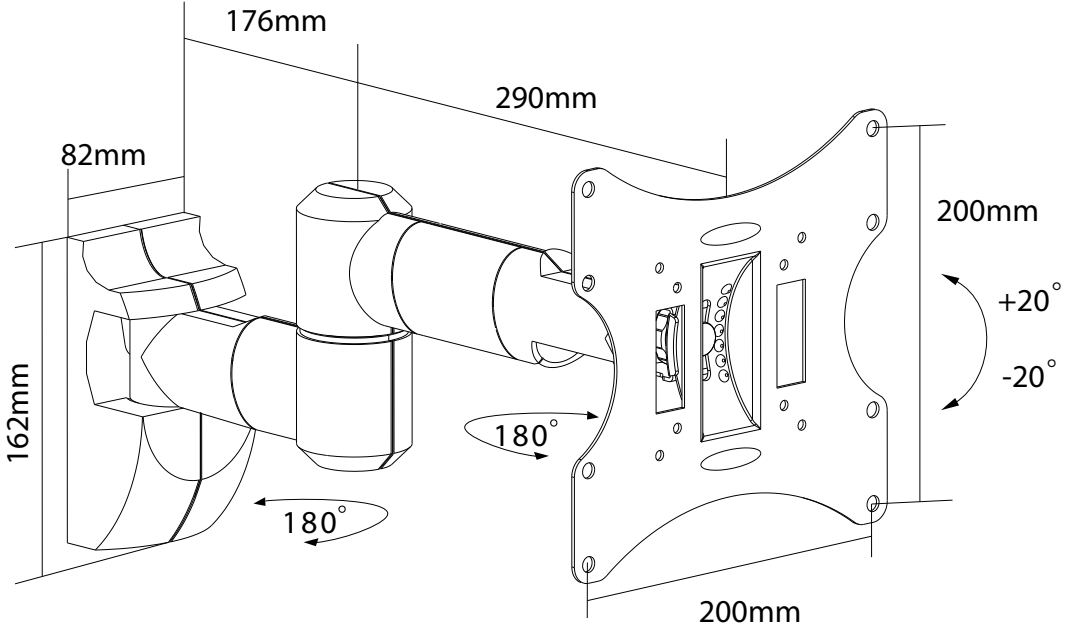

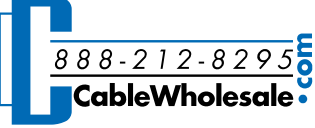
Item Number:	8212-50005	
Title:	TV Mount for 23 to 42 inch w/ 17.7 inch arm, full motion, 75 to 200mm VESA	
Drawn by:	JL	
Approved by:	MAC	
ID:	108	

No.	Specifications
-----	----------------